

# Charleston Series

CH-20

Post Mount

26h x 13.5w x 13.5d

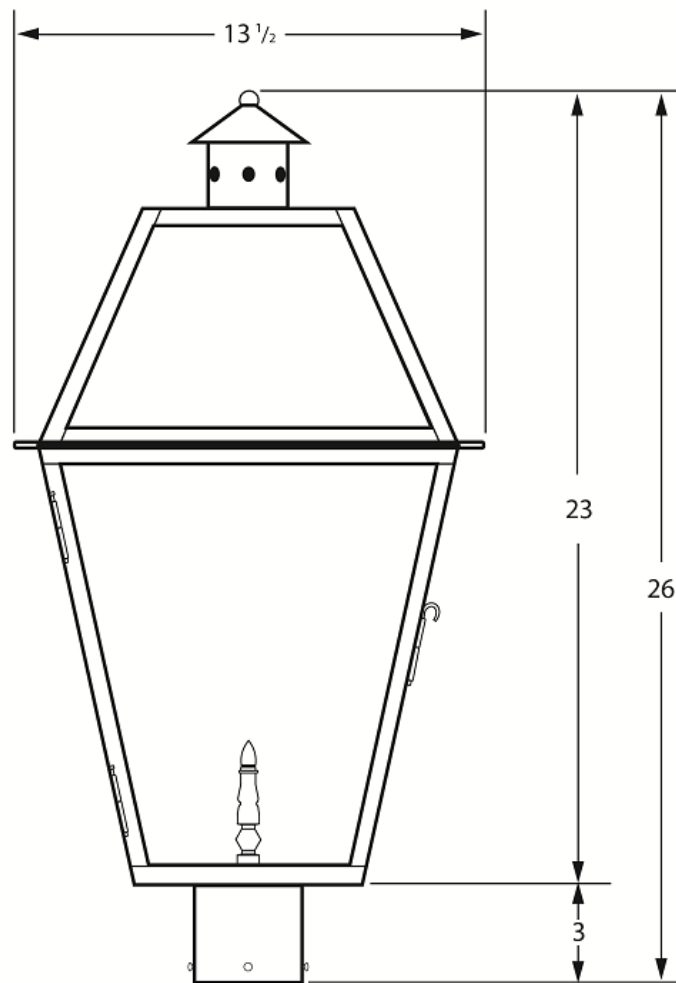

DAMP

BTU's: 1460 for Natural Gas / 1280 for Liquid Propane (LP)



1362 Chuck Dawley Blvd  
Mount Pleasant, SC 29464  
[www.carolinalanterns.com](http://www.carolinalanterns.com)  
[customerservice@carolinalanterns.com](mailto:customerservice@carolinalanterns.com)