

Charleston Series

CH-23

Ceiling Yoke Mount

41h x 18w x 13.5d

*Overall drop can be shortened to 35"

Electric Canopy:

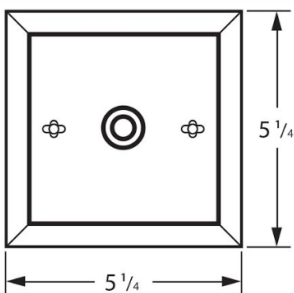

Gas Canopy:

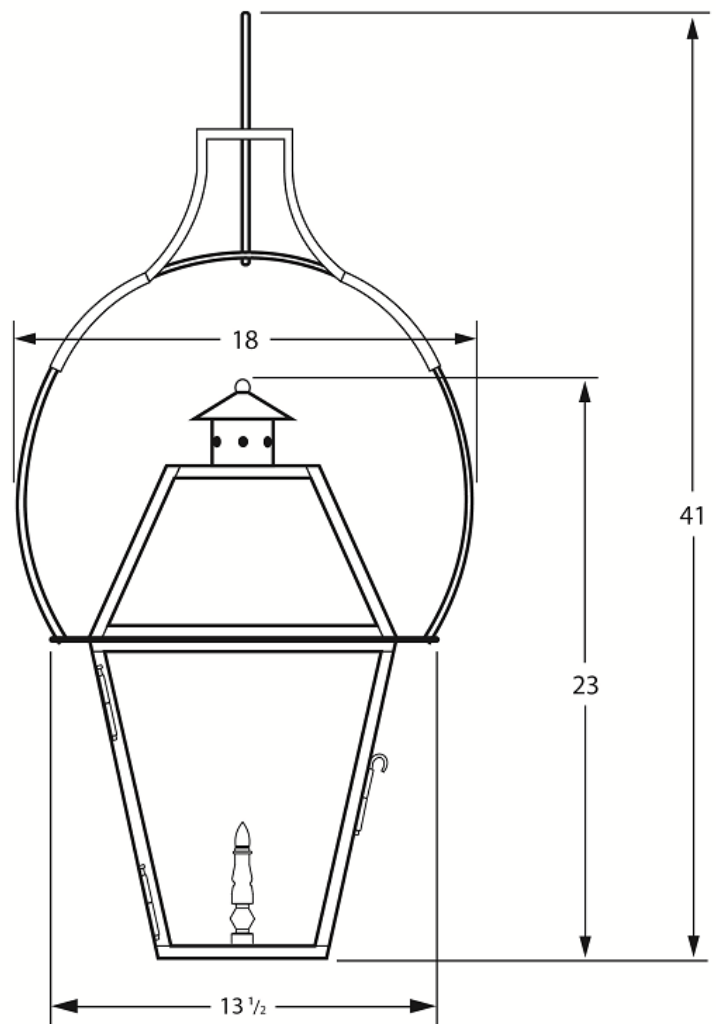
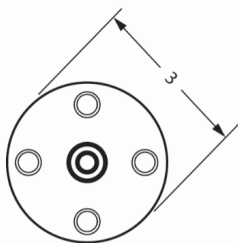

DAMP

BTU's: 1460 for Natural Gas / 1280 for Liquid Propane (LP)



1362 Chuck Dawley Blvd
Mount Pleasant, SC 29464
www.carolinalanterns.com
customerservice@carolinalanterns.com