

Charleston Series

CH-25

Post Mount

20.5h x 10.5w x 10.5d

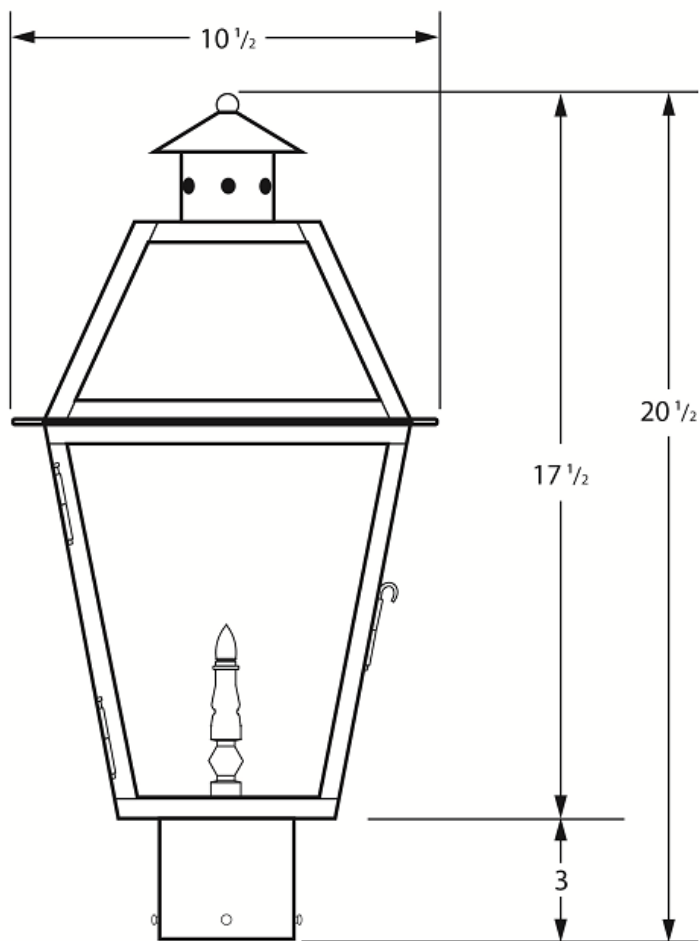

DAMP

BTU's: 1460 for Natural Gas / 1280 for Liquid Propane (LP)



1362 Chuck Dawley Blvd
Mount Pleasant, SC 29464
www.carolinalanterns.com
customerservice@carolinalanterns.com