

Charleston Series

CH-32

Wall Mount

21h x 12.5w x 13.5d

*Mounting hole to top of lantern: 15"

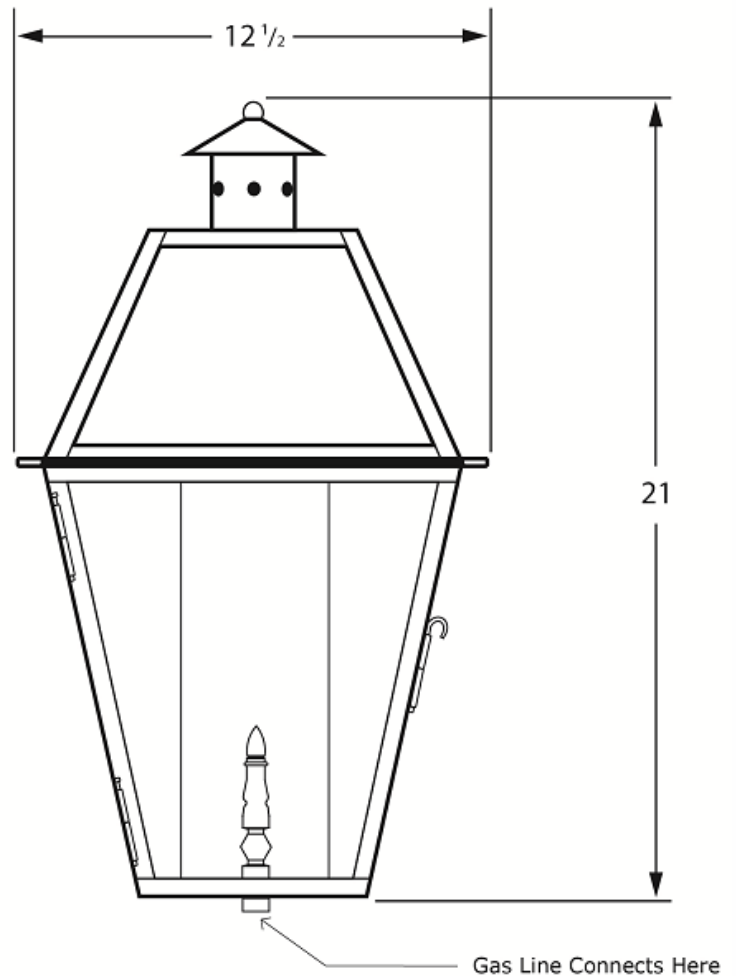
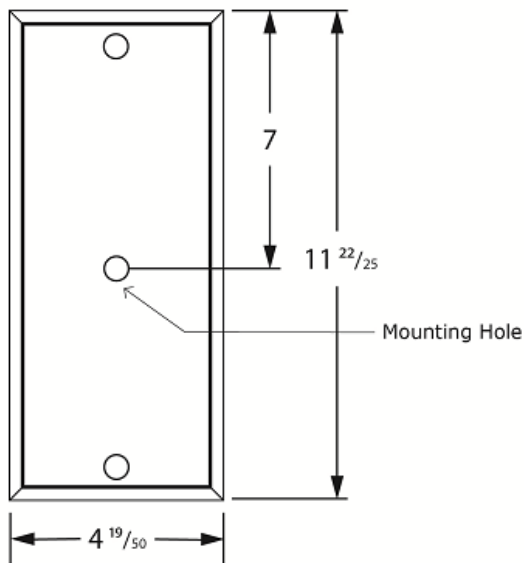

DAMP

BTU's: 1460 for Natural Gas / 1280 for Liquid Propane (LP)



1362 Chuck Dawley Blvd
Mount Pleasant, SC 29464
www.carolinalanterns.com
customerservice@carolinalanterns.com