

Tradd Street II Series

N-26

Hanging Pendant

21h x 10.5w x 10.5d

*Comes with 18" of chain

Canopy:

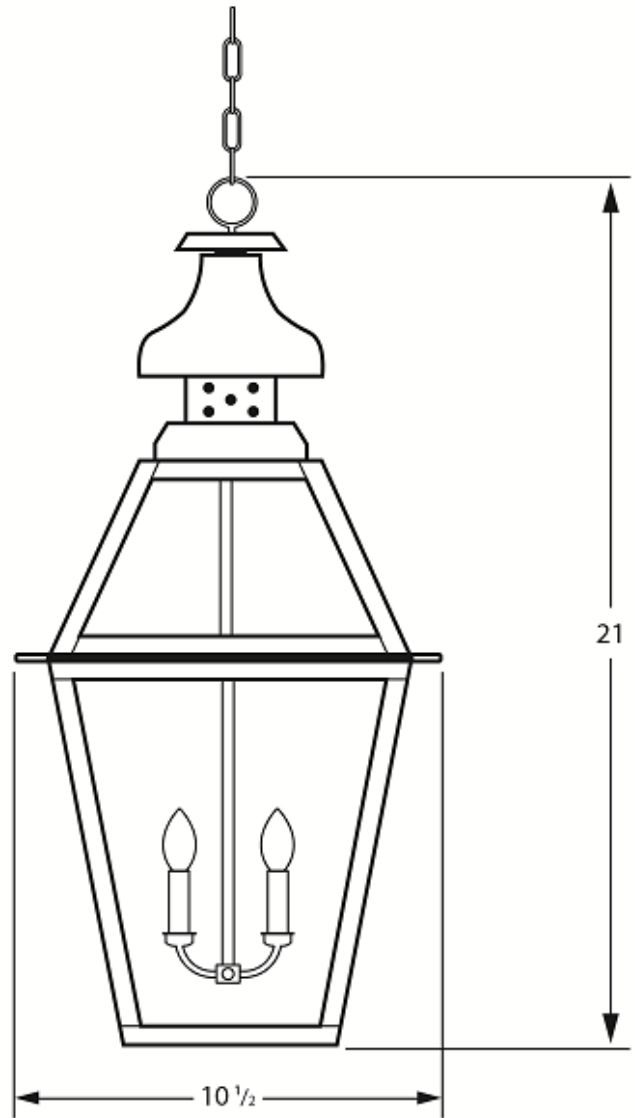
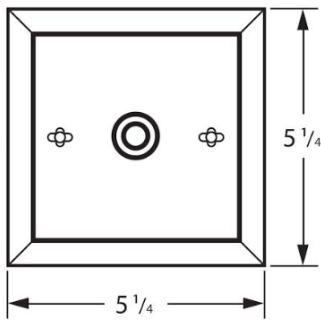

DAMP



1362 Chuck Dawley Blvd
Mount Pleasant, SC 29464
www.carolinalanterns.com
customerservice@carolinalanterns.com